

PLAN DE COUPE 30*30 remplace le plan de coupe A4

30*30 blanc

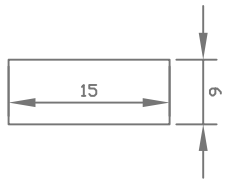

30*30 marron

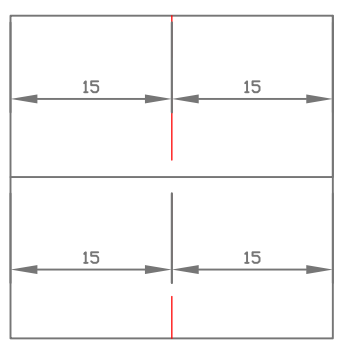
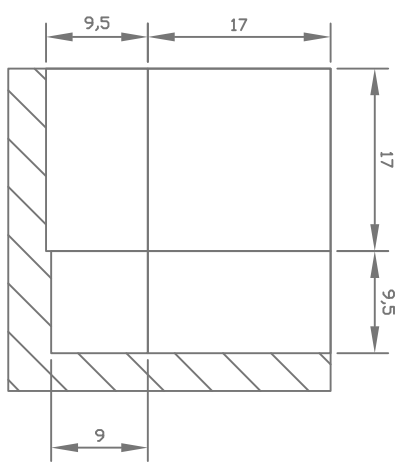

30*30 marron

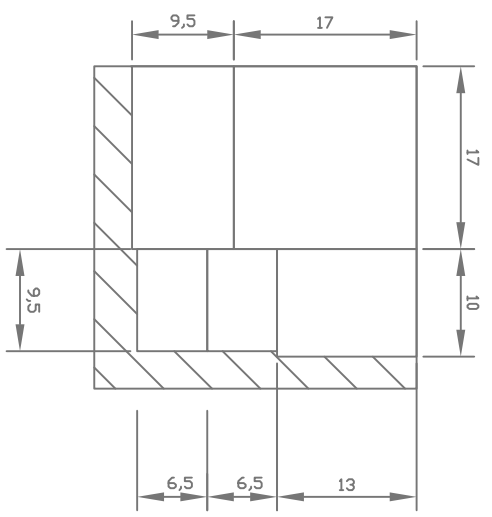

30*30 marron

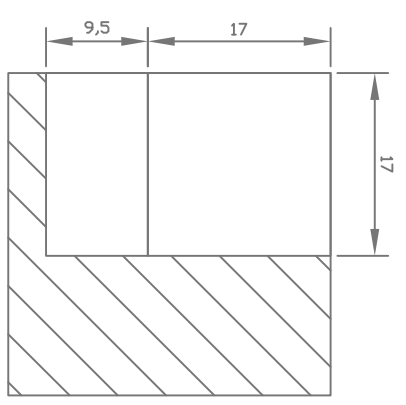

30*30 kraft clair

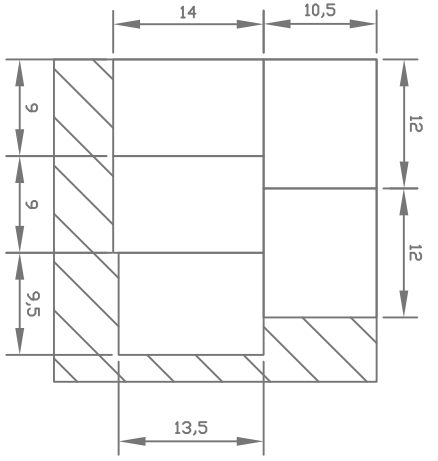

30*30 kraft clair

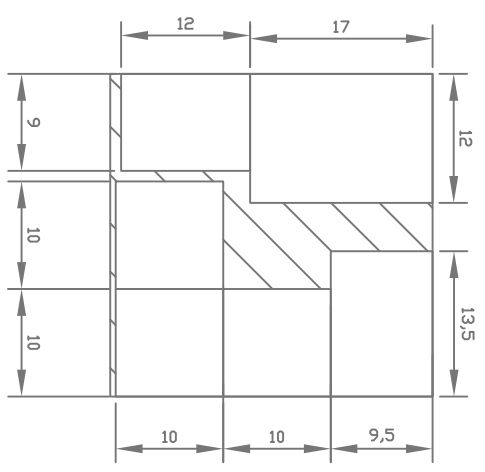

30*30 rouge

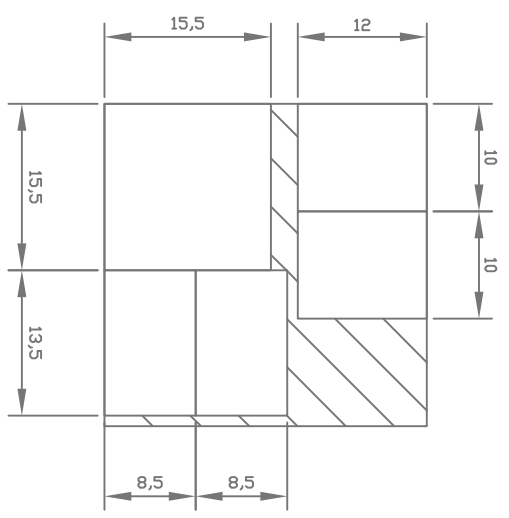

30*30 rouge

